

NEXT GENERATION FOR STRONG WALLS AND FLOORS



HIGH MINERAL COMPOSITE COVERINGS
RECUBRIMIENTOS COMPUESTOS DE ALTA CANTIDAD MINERAL



MATERIASPC
STONE BEST RIGID CORE

EVOLUTION
TO EXCELLENCE

EVOLUCIÓN
HACIA LA EXCELENCIA

MATERIASPC





What are SPC flooring?

They are a new flooring generation, much more technologically advanced than its vinyl predecessors.

The acronym SPC stands for **Solid Polymer Composite**.

It is a material composed of a set of elements, **mainly minerals and PVC**, resulting in a product with unique characteristics:

Great resistance to wear, totally waterproof, non-deformable, very thermally stable, extreme hardness and very light.

¿Qué son los pavimentos SPC?

Son una nueva generación de pavimentos, mucho más avanzados tecnológicamente que sus predecesores vinílicos.

Las siglas SPC significan **Solid Polymer Composite**.
(Compuesto Polimérico Sólido)

Es un material compuesto por un conjunto de elementos, **principalmente minerales y PVC**, obteniendo como resultado un producto con unas características singulares:
gran resistencia al desgaste, totalmente impermeable, indeformable, muy estable térmicamente, dureza extrema y muy, muy ligero, entre otras.

★★★★★

THE MOST
RESISTANT SPC WOOD
IN THE WORLD

LA MADERA SPC
MAS RESISTENTE
DEL MUNDO



INDEX

ÍNDICE

By East Coast SPC, S.A. -	6	- By East Coast SPC, S.A.
Internal structure -	8	- Estructura interna
Our quality -	10	- Nuestra calidad
Technical advantages / Guarantee -	12	- Ventajas técnicas / Garantía
Vinyl flooring comparison -	14	- Comparativa suelos vinílicos
Placement -	16	- Colocación
Logistics / Replacement Service -	18	- Logística / Servicio de reposición
Products «à la carte» -	20	- Productos «a la carta»

MATERIASPC PRODUCTS

PRODUCTOS MATERIASPC

Espiga -	22	- Espiga
Sapin -	28	- Sapin
Noyer -	38	- Noyer
Arancio -	44	- Arancio
Betulla -	54	- Betulla
Carrubo -	64	- Carrubo
Leccio -	72	- Leccio
Marble -	80	- Marble
Stone -	86	- Stone

SPECIAL PARTS / APPLIANCES

PIEZAS ESPECIALES / ACCESORIOS

Coordinated steps, skirtings & profiles -	100	- Peldaños, rodapiés y perfiles coordinados
---	-----	---

TECHNICAL INFORMATION

INFORMACIÓN TÉCNICA

Test and certificates -	102	- Test y certificados
Packing list and displays -	106	- Embalajes y expositores

CONSUMER INFORMATION

INFORMACIÓN PARA EL CONSUMIDOR

Removable -	108	- Desmontable
No CO ₂ footprint in its production -	110	- Sin huella de CO ₂ en su producción



Leading creator and distributor of SPC flooring in Spain

Líderes en la creación y distribución de suelos SPC en España

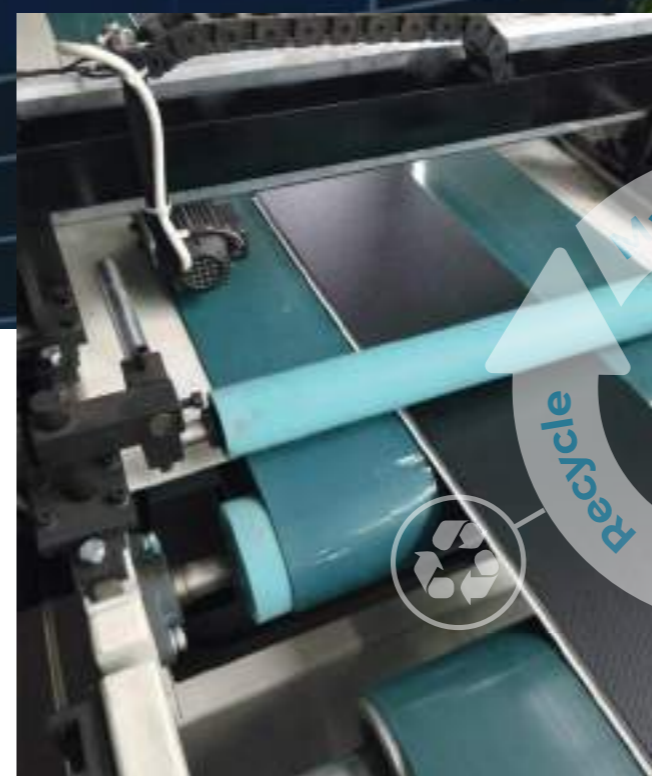

By EAST COAST SPC, S.A.

State-of-the-art technology that guarantees prompt service and quality products

We work very closely with our producing partners to manufacture our latest designs with the most advanced technology.

We have invested in the latest technology to guarantee the highest product quality and prompt delivery, sustainability, optimization and resource recycling (0% waste) as well as the use of clean energy (about 80% derived from solar energy) throughout the production cycle.

Tecnología de última generación que garantiza agilidad en el servicio y calidad en el producto

Trabajamos en estrecha colaboración con nuestros socios productores para fabricar nuestros últimos diseños con la tecnología más avanzada.

Hemos dotado a nuestras instalaciones con los últimos avances tecnológicos que garantizan la más alta calidad de nuestros productos y la rapidez en la entrega de los pedidos, la sostenibilidad, la optimización y el reciclado de los recursos (0% deshechos) así como el empleo de energía limpia (un 80% procedente de autoconsumo solar) en todo el proceso.

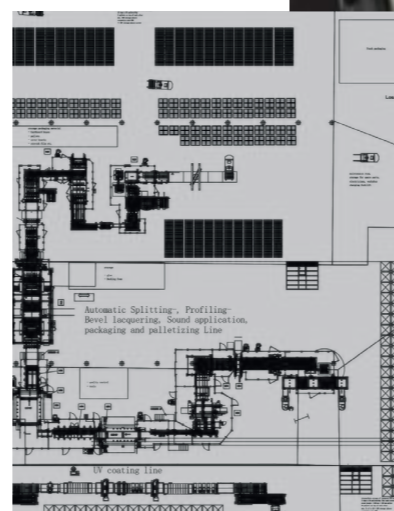

Our Warehouse are equipped with solar panels that provide all our energy needs, thus helping to keep a clean environment.

Nuestro almacén está equipado con paneles solares que cubren todas nuestras necesidades energéticas, contribuyendo así a mantener un medio ambiente limpio.

Evolution to excellence
La evolución hacia la excelencia

MATERIA SPC

STONE BEST RIGID CORE

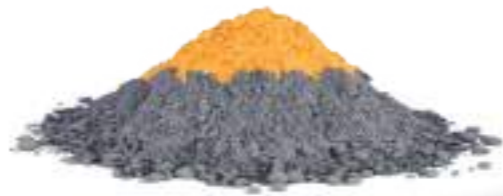

77% Mineral + 23% other components

An extraordinary combination
that makes the difference

Una combinación extraordinaria
que marca la diferencia



Core thickness between
3,5 mm and 5 mm

Esesor del núcleo entre
3,5 mm y 5 mm

Extreme thinness that concentrates technological efficiency

The arrangement of the materials and the formula used in its manufacture achieve **a product with properties much superior** to those of each of its components separately, resulting in a composite material with characteristics of impermeability, rigidity, resistance, lightness, comfort, thermostability, hardness and soundproofing **that are difficult to beat with other flooring.**

* Depending on format and use.
Dependiendo del formato y uso.

Una delgadez extrema que concentra eficiencia tecnológica

La disposición de los materiales y la fórmula empleada en su fabricación da como resultado **un producto con unas propiedades muy superiores** a las de cada uno de sus componentes por separado, dando como resultado un material compuesto con características de impermeabilidad, rigidez, resistencia, ligereza, confort, termoestabilidad, dureza e insonorización **difícilmente superables por otros pavimentos.**

Destined
to endure
Destinados a perdurar

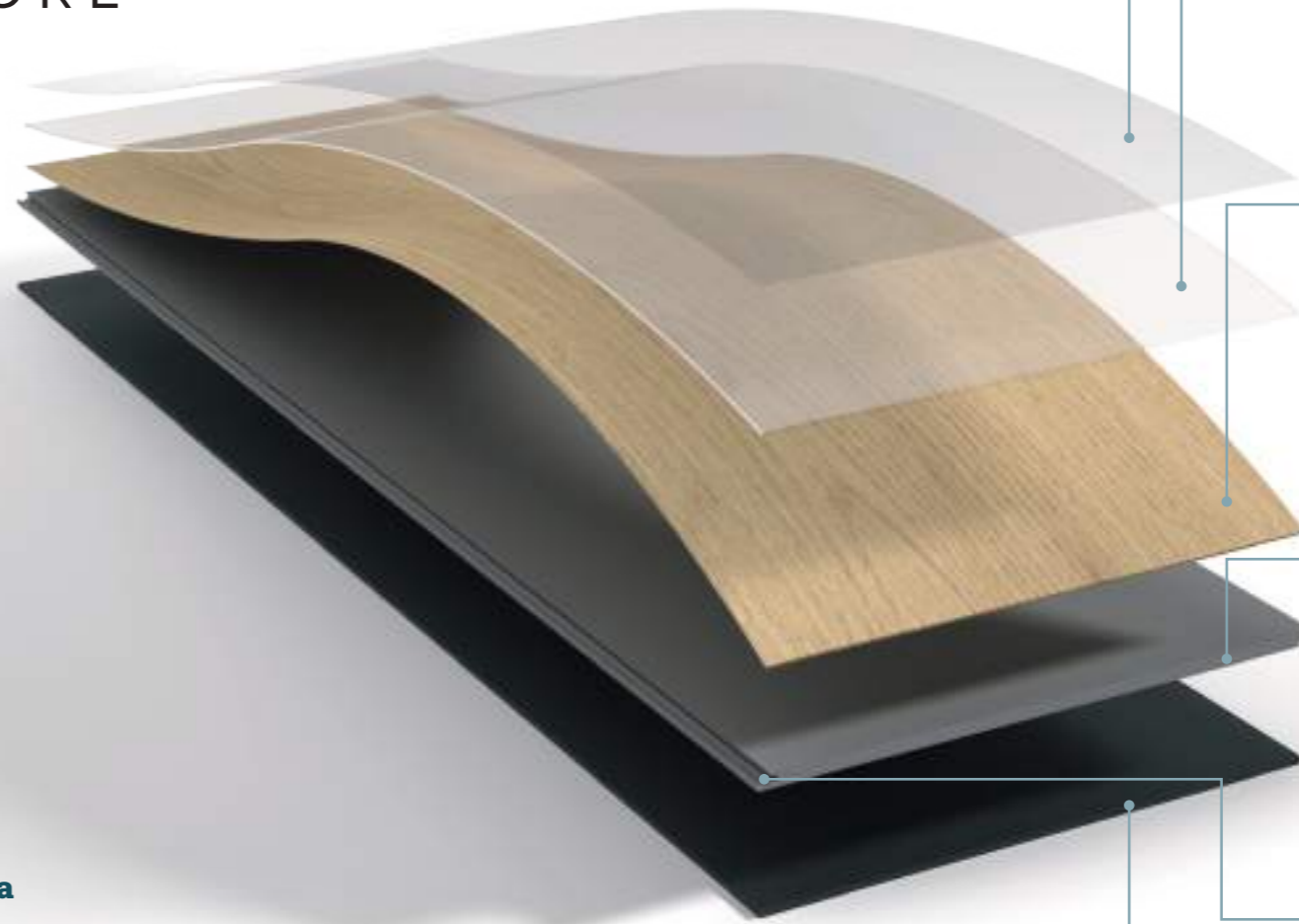

UV protection layer
Provides extra durability and protects colors.
Capa de protección contra rayos UV
Proporciona durabilidad extra y protege los colores.



Protective wear layer
Protective wear layer prevents excessive wear, gives scratch resistance and provides superior protection against stains and bumps.

Capa protectora de desgaste
Previene el desgaste excesivo, aporta resistencia al rayado y proporciona una protección superior contra las manchas y los golpes.



High definition decorative layer
Realistic designs are printed in high resolution, creating a unique natural style.

Capa decorativa de alta definición
Los diseños realistas se imprimen en alta resolución, creando un estilo natural único.



Mineral powder laminated core
Exclusive rigid core. 100% waterproof, prevents expansion and contraction. No bending.

Núcleo de polvo mineral laminado
Núcleo rígido exclusivo. 100% impermeable, previene la expansión y contracción. No se curva.



Click Installation
Easy, clean and effortless assembly.

Instalación con Click
Montaje fácil, limpio y sin esfuerzo.



EVA underlayment for acoustic isolation
Insulates acoustically, fixes the product on the surface and absorbs imperfections from the subfloor. Adhesive-free installation, directly on the ground.

Manto de aislamiento acústico EVA
Aísla acústicamente, fija el producto sobre la superficie y absorbe las imperfecciones del subsuelo. Instalación sin adhesivos, directamente sobre el suelo.

A new covering generation is here
Una nueva generación de recubrimientos está aquí

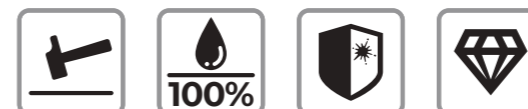

Quality for the most demanding ones
Calidad para los más exigentes

**Innovation,
comfort, design and economy**

A product that has it all.

The incessant search for solutions that improve what is known, the research and development of new, more efficient and sustainable compounds, the application of the latest technologies and the monitoring of design trends, drive us to offer innovative, technologically advanced products, according to the times that we live in, that cover the new needs of the consumer at competitive prices, always **complying with the highest quality standards demanded.**

**Innovación,
confort, diseño y economía**

Un producto que lo tiene todo.

La búsqueda incesante de soluciones que mejoren lo conocido, la investigación y el desarrollo de nuevos compuestos más eficientes y sostenibles, la aplicación de las últimas tecnologías y el seguimiento de las tendencias en diseño nos impulsan a ofrecer productos innovadores, tecnológicamente avanzados, acordes a los tiempos que vivimos, que cubran las nuevas necesidades del consumidor a precios competitivos siempre **cumpliendo con los más altos estándares de calidad exigidos.**



CHILD AND PET PROOF

Due to its resistance to impacts, liquids and stains, it is the ideal covering for use in any room in the house, even in bathrooms and kitchens.

A PRUEBA DE NIÑOS Y MASCOTAS

Por su resistencia a los golpes, a los líquidos y a las manchas es el recubrimiento ideal para su uso en cualquier estancia de la casa, incluso en baños y cocinas.



EASY CLEANING

No special treatments are necessary for optimal maintenance.

FÁCIL LIMPIEZA

No son necesarios tratamientos especiales para su óptimo mantenimiento.

*All proof!
¡Resistente a todo!*

Technical advantages of MATERIASPC coverings Ventajas técnicas de los recubrimientos MATERIASPC



GARANTÍA LIMITADA
LIMITED WARRANTY
30 YEARS



GARANTÍA LIMITADA
LIMITED WARRANTY
15 YEARS



- | | | |
|---|---|--|
| 100% Waterproof
Impermeable | Bfl-s1 Fireproof
Ignifugo | Suitable for wall and floor surfaces
Apto para suelo y pared |
| Scratch resistant
Resistente a rayaduras | Wear resistant
Resistente al desgaste | Impact resistant
Resistente a los golpes |
| Stain resistant
Resistente a las manchas | Without maintenance
Sin mantenimiento | ULTRA MATT Anti-glare technology
Tecnología anti-brillos |
| dB 17 Reduces impact noise
Reduce el ruido de impactos | UV UV resistant
Resiste a los rayos UV | 50 Acoustically isolating
Aísla acústicamente |
| Anti-slip
Antideslizante | Perfect use between 5°C and 40°C
Uso perfecto entre 5°C y 40°C | Does not dilate
No dilata |
| CH₂O No toxic or allergic components
Sin componentes tóxicos o alérgicos | Suitable for babies
Apto para bebés | Suitable for hydraulic underfloor heating
Apto para suelos radiantes por agua |
| Does not generate static electricity
No genera electricidad estática | Bacterial and fungi resistant
Resistente a bacterias y hongos | Ideal for pets
Ideal para mascotas |
| Very realistic finish
Acabado muy realista | Reusable
Reutilizable | Resistant to pests
Resistente a las plagas |
| 24 h Does not need acclimatization
No necesita aclimatación | Effortless
Sin esfuerzo | Installation on any surface
Instalación sobre cualquier superficie |
| Without joints up to 225 m²
Sin juntas hasta 225 m² | CLICK Easy assembly
Fácil Montaje | No works
Sin obras |
| CO₂ No CO ₂ emissions in its manufacture
Sin emisiones de CO ₂ en su fabricación | | Quick assembly
Montaje rápido |



The best guarantee of the market La mayor garantía del mercado

A highly resistant covering "composite" of benefits

You only have to take a look at these pages to realize the excellence of this new product. **They are the latest generation of mineral composite based coverings.**

We are very satisfied with its long-term performance. The results of the tests carried out demonstrate this and thus we pass it on to the consumer, offering them an almost "lifetime" guarantee that very few dare to match.

Un recubrimiento muy resistente «compuesto» de ventajas

Solo hay que echar un vistazo a estas páginas para darse cuenta de la excelencia de este nuevo producto. **Son la última generación de recubrimientos con base de compuesto mineral.**

Estamos muy satisfechos con su rendimiento a largo plazo. Los resultados de los tests realizados así lo demuestran y así se lo trasladamos al consumidor, ofreciéndole una garantía casi "de por vida" que muy pocos se atreven a igualar.

MATERIA SPC coverings versus LVT, WPC and WOOD

Recubrimientos MATERIA SPC frente LVT, WPC y MADERA

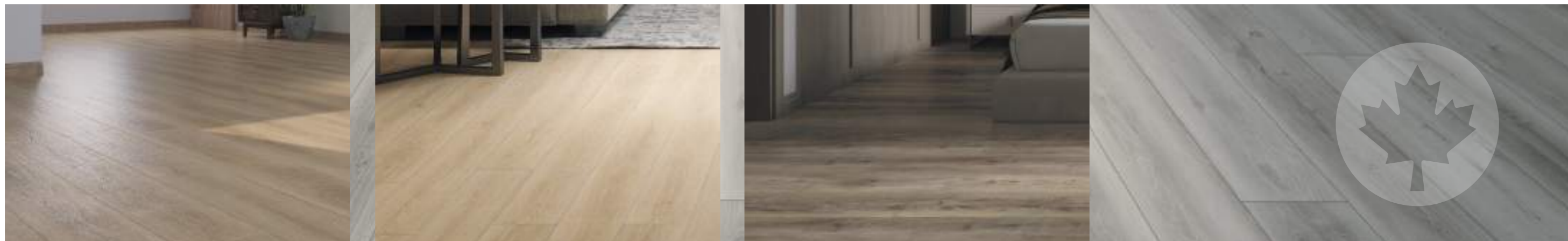

A deserved excellence

Una merecida excelencia

Floor comparison

Comparative tests carried out against other coatings demonstrate the excellent qualities of our high-quality mineral composite floors, far surpassing vinyl floors manufactured to date.

Undoubtedly, **arguments of great weight when deciding the purchase decision** over other products.

An unrivaled coating for all types of interiors.

Comparativa de suelos

Las pruebas comparativas realizadas con respecto a otros recubrimientos demuestran las excelentes cualidades de nuestros pavimentos de composite mineral de alta calidad, superando por mucho a los suelos vinílicos fabricados hasta la fecha.

Sin duda, **argumentos de mucho peso a la hora de decantar la decisión de compra** frente a otros productos.

Un revestimiento para todo tipo de interiores sin rival.

	MATERIASPC STONE BEST RIGID CORE	LVT	WPC	LAMINATED WOOD
Wear resistance Resistencia al desgaste				
Waterproof Resistencia al agua				
No expansion or contraction Sin dilatación ni contracción				
High/low temperature stability Estabilidad en alta/baja temperatura				
Installation on any surface Instalación sobre cualquier superficie				
Scratch resistant Resistente a rayaduras				
Soundproofing capacity Capacidad de insonorización				
Pet friendly Apto para mascotas				
Easy assembly Fácil instalación				
Suitable for sunny rooms Adecuado para estancias soleadas				
Free of formaldehyde Libre de formaldehídos				
Impact resistant Resistente a los impactos				

Laying the MATERIASPC floorings Colocación de los pavimentos MATERIASPC

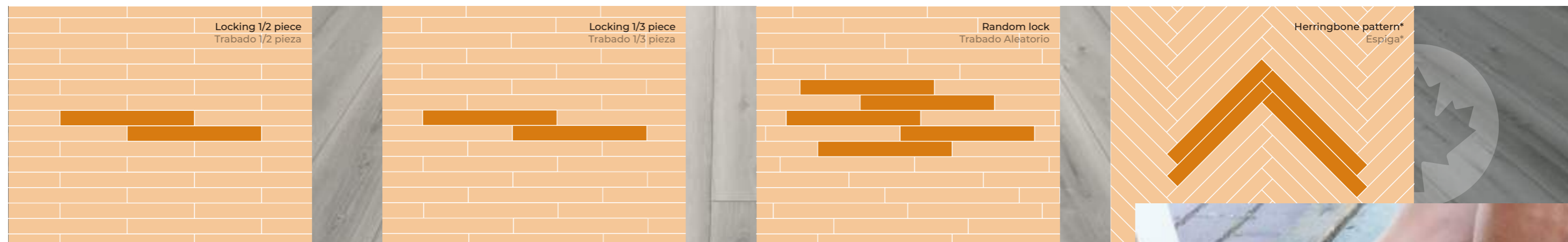

Fit, CLICK... and voilà!
Encajar, CLICK... ¡Y listo!

Much easier than assembling a puzzle

It does not matter on which surface our MATERIASPC floors are installed: cement, concrete, old ceramic floors, wood ... the only requirement is that the surface **be solid, smooth and dry**.

No adhesives or additional supports.
No dust. No debris. Effortless.

Mucho más sencillo que montar un puzle

No importa sobre qué superficie se instalen nuestros suelos MATERIASPC: cemento, hormigón, antiguos pavimentos cerámicos, madera... el único requisito es que la superficie **sea sólida, lisa y seca**.

Sin adhesivos ni soportes adicionales.
Sin polvo. Sin escombros. Sin esfuerzo.



See assembly instructions in
www.materiaspc.com



Ver instrucciones de montaje en
www.materiaspc.com

DIFFERENT POSSIBILITIES OF PLACEMENT DISTINTAS POSIBILIDADES DE COLOCACIÓN



NO PRIOR KNOWLEDGE REQUIRED
It is so simple to assemble that anyone can install MATERIASPC floors with the few tools necessary..

SIN CONOCIMIENTOS PREVIOS
Es tan sencillo de ensamblar que cualquiera puede instalar los suelos MATERIASPC disponiendo de las pocas herramientas necesarias.

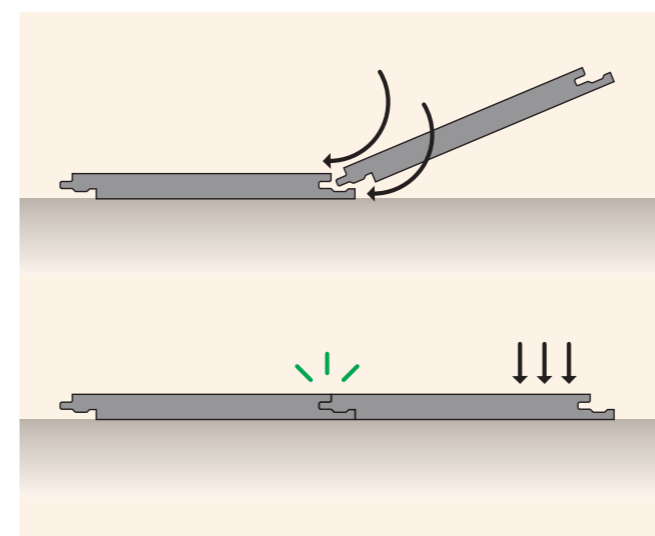

* HERRINGBONE PATTERN / COLOCACIÓN EN ESPIGA
See specific products. Ver productos específicos.



FLOOR AND WALL SUITABLE
APTO PARA SUELO Y PARED



WITHOUT EXPANSION JOINTS

They are not necessary except in cases where the surface to be covered exceeds 15 m linear from end to end (225 m²).

SIN JUNTAS DE DILATACIÓN

No son necesarias salvo en casos en los que la superficie a cubrir supere los 15 m lineales de extremo a extremo (225 m²).

Logistics & Service
Logística & Servicio



Immediate replacement service
Servicio inmediato de reposición

PRODUCT LOADING ADDRESS
DIRECCIÓN DE CARGAS

EAST COAST SPC
Carretera CV-20. Km 5.
12200 Onda (Castellón)
SPAIN

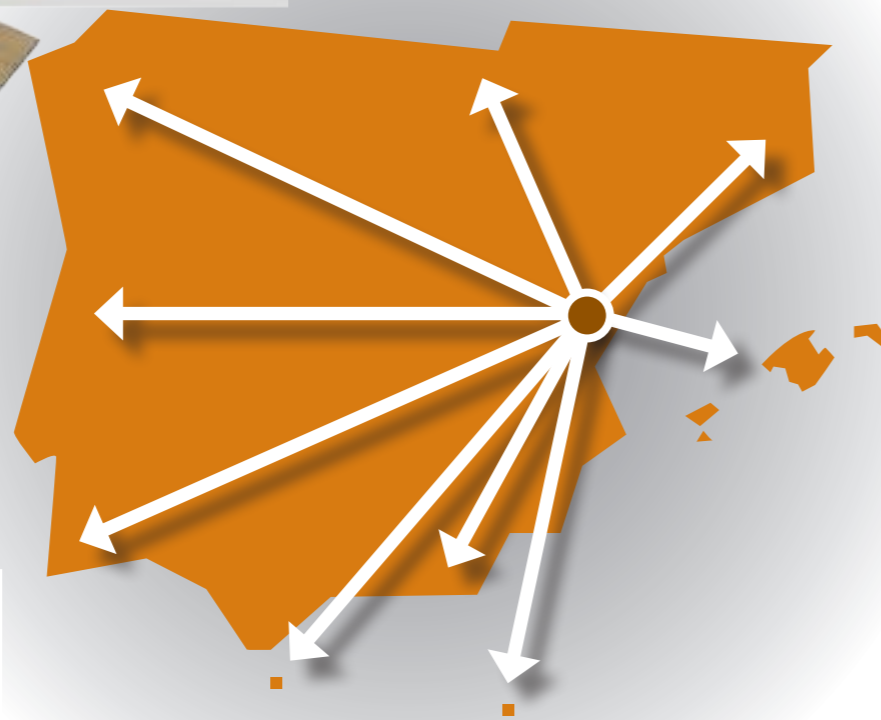

5 business days
to any point of Spain and Portugal

The quantity does not matter. From our logistics center we guarantee the delivery of your order in record time.

You will save space in your facilities by not needing to store product stock and peace of mind knowing that your order will be delivered in the set time.

No delays.

5 días hábiles
a cualquier punto de la península

No importa la cantidad. Desde nuestro centro logístico garantizamos la entrega de su pedido en tiempo récord.

Ganará espacio en sus instalaciones al no necesitar almacenar stock de producto y tranquilidad al saber que su pedido será entregado en el tiempo fijado.

Sin retrasos.



Large projects Grandes proyectos



Manufacture «à la carte» Fabricación «a la carta»

FOR LARGE ORDERS (several containers)

We put at your disposal our exclusive «à la carte» product service with which you can create your own configuration of the piece combining materials and layer thicknesses based on the technical, aesthetic and economic requirements of the final product you want to obtain.

PARA GRANDES PEDIDOS (varios contenedores)

Ponemos a su disposición nuestro servicio exclusivo de producto «a la carta» con el que podrá crear su propia configuración de la pieza, combinando materiales y espesores de las capas en función de los requisitos técnicos, estéticos y económicos del producto final que desee obtener.

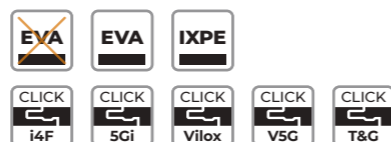

WIDE RANGE OF ASSEMBLY AND SOUNDPROOFING SYSTEMS

Contact us and we will offer you competitive solutions for your project.

GRAN VARIEDAD EN SISTEMAS DE ENSAMBLADO E INSONORIZACIÓN

Consúltenos y le ofreceremos soluciones competitivas para su proyecto.

Make your own pavement «recipe»

We put at your disposal all our **manufacturing potential** to adhere to your specifications based on your needs, covering all the technical aspects of the final product, combinations of materials and thicknesses, advice, dimensions, finishes and of course design, **to create the perfect flooring** that your big project requires. Always within the required quality standards.

We are open to any proposal that you could make us. **Contact us.**

Confeccione su propia «receta» de pavimento

Ponemos a su disposición todo nuestro **potencial de fabricación** para ceñirnos a sus especificaciones técnicas en función de sus necesidades, abarcando todos los aspectos técnicos del producto final, combinaciones de materiales y espesores, asesoramiento, dimensiones, acabados y por supuesto diseño, **para crear el pavimento perfecto** que requiere su gran proyecto. Siempre dentro de los estándares de calidad exigidos.

Estamos abiertos a cualquier propuesta que pueda realizarnos. **Contacte con nosotros.**

HERRINGBONE SERIES
COLECCIÓN ESPIGA

CRISTINA

BEIGE



HERRINGBONE SERIES
COLECCIÓN ESPIGA

MADI

NATURAL



CRISTINA BEIGE

HERRINGBONE SERIES
COLECCIÓN ESPIGA

CRISTINA



CRISTINA BEIGE
12,6 x 63 cm - 5" x 24,8"



MADI NATURAL
12,6 x 63 cm - 5" x 24,8"

Suitable for Apto para	
Total thickness (mm) Espesor total (mm)	5,5
Thickness core (mm) Espesor del núcleo (mm)	4,5
Wear layer Capa de uso	0,5 mm
Click type Tipo de click	CLICK 5Gi
Underlayment for acoustic isolation Aislamiento Acústico	17 dB 1mm IXPE
Microbevelled edge Micro-bisel	MICRO
Standard relief Relieve estándar	
Waterproof Impermeable	100%
Anti slip - R9 Antideslizante - R9	
Anti-glare technology Tecnología anti-brillos	ULTRA MATT



Coordinated steps, skirtings & profiles
Peldaños, rodapiés y perfiles coordinados

12,6 x 63 cm
5" x 24,8"



Stock available - Stock disponible

Top sales - Top ventas

WOOD SERIES
COLECCIÓN MADERAS



SAPIN

WHITE



SAPIN

BEIGE



SAPIN

HAYA



SAPIN

HAYA



WHITE

WOOD SERIES
COLECCIÓN MADERAS

SAPIN



SAPIN HAYA

🏆 18,2 x 122 cm - 7,2" x 48"
22,8 x 154 cm - 9" x 60,6"



SAPIN BEIGE

🏆 18,2 x 122 cm - 7,2" x 48"
22,8 x 154 cm - 9" x 60,6"



SAPIN WHITE

🏆 18,2 x 122 cm - 7,2" x 48"
22,8 x 154 cm - 9" x 60,6"

Suitable for
Apto para

Total thickness (mm)
Espesor total (mm) **5,5**

Thickness core (mm)
Espesor del núcleo (mm) **4,5**

Wear layer
Capa de uso **0,5 mm**

Click type
Tipo de click **CLICK i4F**

Total thickness (mm)
Espesor total (mm) **5**

Thickness core (mm)
Espesor del núcleo (mm) **4**

Wear layer
Capa de uso **0,5 mm**

Click type
Tipo de click **CLICK i4F**

Underlayment for
acoustic isolation **1mm EVA**
Aislamiento Acústico **17 dB**

Microbevelled edge
Micro-bisel **MICRO**

Standard relief
Relieve estándar

Waterproof
Impermeable **100%**

Anti slip - R9
Antideslizante - R9

22,8 x 154 cm

18,2 x 122 cm

22,8 x 154 cm
9" x 60,6"

18,2 x 122 cm
7,2" x 48"



Coordinated steps, skirtings & profiles
Peldaños, rodapiés y perfiles coordinados

🏆 Stock available - Stock disponible

🏆 Top sales - Top ventas

WOOD SERIES
COLECCIÓN MADERAS

NOYER

HAYA



NOYER

BEIGE



HAYA

WOOD SERIES
COLECCIÓN MADERAS

NOYER



NOYER HAYA

- 18,2 x 122 cm - 7,2" x 48"
- 22,8 x 154 cm - 9" x 60,6"



NOYER BEIGE

- 18,2 x 122 cm - 7,2" x 48"
- 22,8 x 154 cm - 9" x 60,6"

Suitable for
Apto para



Total thickness (mm)
Espesor total (mm)



Thickness core (mm)
Espesor del núcleo (mm)



Wear layer
Capa de uso



Click type
Tipo de click



22,8 x 154 cm

Total thickness (mm)
Espesor total (mm)



Thickness core (mm)
Espesor del núcleo (mm)



Wear layer
Capa de uso



Click type
Tipo de click



18,2 x 122 cm

Underlayment for
acoustic isolation
Aislamiento Acústico



Microbevelled edge
Micro-bisel



Standard relief
Relieve estándar



Waterproof
Impermeable



Anti slip - R9
Antideslizante - R9



22,8 x 154 cm
9" x 60,6"

18,2 x 122 cm
7,2" x 48"



Coordinated steps, skirtings & profiles
Peldaños, rodapiés y perfiles coordinados

Stock available - Stock disponible

Top sales - Top ventas

WOOD SERIES
COLECCIÓN MADERAS

ARANCIO

LIGHT GREY



ARANCIO

TAUPE



ARANCIO

BEIGE



ARANCIO

BROWN



ARANCIO



ARANCIO LIGHT GREY

- 18,2 x 122 cm - 7,2" x 48"
- 22,8 x 154 cm - 9" x 60,6"

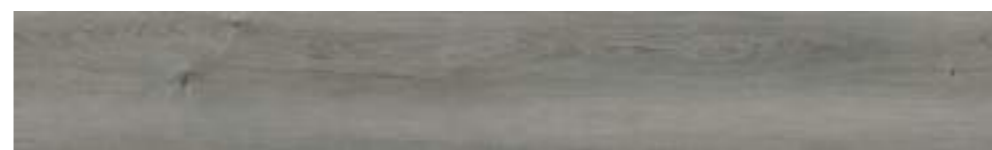

ARANCIO TAUPE

- 18,2 x 122 cm - 7,2" x 48"
- 22,8 x 154 cm - 9" x 60,6"



ARANCIO BEIGE

- 18,2 x 122 cm - 7,2" x 48"
- 22,8 x 154 cm - 9" x 60,6"



ARANCIO BROWN

- 18,2 x 122 cm - 7,2" x 48"
- 22,8 x 154 cm - 9" x 60,6"

Suitable for
Apto para



Total thickness (mm)
Espesor total (mm)



Thickness core (mm)
Espesor del núcleo (mm)



Wear layer
Capa de uso



Click type
Tipo de click



Total thickness (mm)
Espesor total (mm)



Thickness core (mm)
Espesor del núcleo (mm)



Wear layer
Capa de uso



Click type
Tipo de click



Underlayment for
acoustic isolation
Aislamiento Acústico



Microbevelled edge
Micro-bisel



Standard relief
Relieve estándar



Waterproof
Impermeable



Anti slip - R9
Antideslizante - R9



22,8 x 154 cm
9" x 60,6"

18,2 x 122 cm
7,2" x 48"



Coordinated steps, skirtings & profiles
Peldaños, rodapiés y perfiles coordinados

Stock available - Stock disponible

Top sales - Top ventas

WOOD SERIES
COLECCIÓN MADERAS

BETULLA

BONE



BETULLA

NATURAL



BETULLA

ROBLE



BETULLA

GREY



BETULLA



BETULLA BONE

- 18,2 x 122 cm - 7,2" x 48"
- 22,8 x 154 cm - 9" x 60,6"



BETULLA NATURAL

- 18,2 x 122 cm - 7,2" x 48"
- 22,8 x 154 cm - 9" x 60,6"



BETULLA ROBLE

- 18,2 x 122 cm - 7,2" x 48"
- 22,8 x 154 cm - 9" x 60,6"

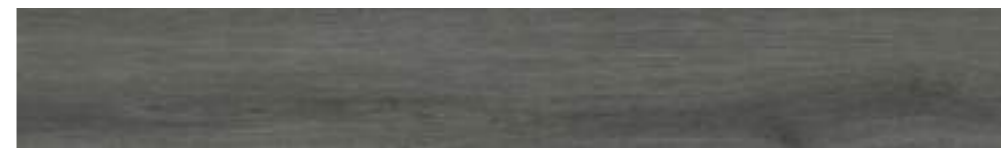

BETULLA GREY

- 18,2 x 122 cm - 7,2" x 48"
- 22,8 x 154 cm - 9" x 60,6"

Suitable for
Apto para

Total thickness (mm)
Espesor total (mm) **5,5**

Thickness core (mm)
Espesor del núcleo (mm) **4,5**

Wear layer
Capa de uso **0,5 mm**

Click type
Tipo de click **CLICK i4F**

Total thickness (mm)
Espesor total (mm) **5**

Thickness core (mm)
Espesor del núcleo (mm) **4**

Wear layer
Capa de uso **0,5 mm**

Click type
Tipo de click **CLICK i4F**

Underlayment for
acoustic isolation **17 dB**
Aislamiento Acústico **17**

Microbevelled edge
Micro-bisel **MICRO**

Standard relief
Relieve estándar

Waterproof
Impermeable **100%**

Anti slip - R9
Antideslizante - R9

22,8 x 154 cm

18,2 x 122 cm

22,8 x 154 cm
9" x 60,6"

18,2 x 122 cm
7,2" x 48"



Coordinated steps, skirtings & profiles
Peldaños, rodapiés y perfiles coordinados

Stock available - Stock disponible

Top sales - Top ventas

WOOD SERIES
COLECCIÓN MADERAS

CARRUBO

BEIGE



CARRUBO

COFFEE



CARRUBO

BLANCO



CARRUBO



CARRUBO COFFEE

18,2 x 122 cm - 7,2" x 48"
22,8 x 154 cm - 9" x 60,6"



CARRUBO BEIGE

18,2 x 122 cm - 7,2" x 48"
22,8 x 154 cm - 9" x 60,6"



CARRUBO BLANCO

18,2 x 122 cm - 7,2" x 48"
22,8 x 154 cm - 9" x 60,6"

Suitable for Apto para	
Total thickness (mm) Espesor total (mm)	5,5
Thickness core (mm) Espesor del núcleo (mm)	4,5
Wear layer Capa de uso	0,5 mm
Click type Tipo de click	CLICK i4F
<hr/>	
Total thickness (mm) Espesor total (mm)	5
Thickness core (mm) Espesor del núcleo (mm)	4
Wear layer Capa de uso	0,5 mm
Click type Tipo de click	CLICK i4F
<hr/>	
Underlayment for acoustic isolation Aislamiento Acústico	dB 17 1mm EVA
Microbevelled edge Micro-bisel	MICRO
Standard relief Relieve estándar	
Waterproof Impermeable	100%
Anti slip - R9 Antideslizante - R9	

22,8 x 154 cm

18,2 x 122 cm

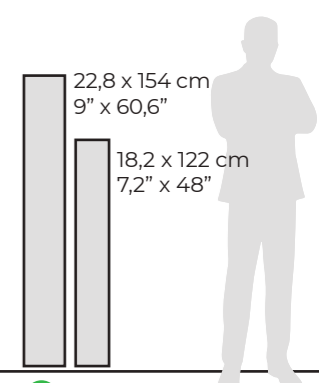

Coordinated steps, skirtings & profiles
Peldaños, rodapiés y perfiles coordinados

Stock available - Stock disponible

Top sales - Top ventas

WOOD SERIES
COLECCIÓN MADERAS

LECCIO

HAYA

LECCIO

BEIGE



LECCIO

GREY



BEIGE

WOOD SERIES
COLECCIÓN MADERAS

LECCIO



LECCIO HAYA

18,2 x 122 cm - 7,2" x 48"
22,8 x 154 cm - 9" x 60,6"



LECCIO BEIGE

18,2 x 122 cm - 7,2" x 48"
22,8 x 154 cm - 9" x 60,6"



LECCIO GREY

18,2 x 122 cm - 7,2" x 48"
22,8 x 154 cm - 9" x 60,6"

Suitable for Apto para	
Total thickness (mm) Espesor total (mm)	5,5
Thickness core (mm) Espesor del núcleo (mm)	4,5
Wear layer Capa de uso	0,3 mm
Click type Tipo de click	CLICK i4F
<hr/>	
Total thickness (mm) Espesor total (mm)	5
Thickness core (mm) Espesor del núcleo (mm)	4
Wear layer Capa de uso	0,3 mm
Click type Tipo de click	CLICK i4F
<hr/>	
Underlayment for acoustic isolation Aislamiento Acústico	17 dB 1mm EVA
Microbevelled edge Micro-bisel	MICRO
Standard relief Relieve estándar	
Waterproof Impermeable	100%
Anti slip - R9 Antideslizante - R9	

22,8 x 154 cm

18,2 x 122 cm

22,8 x 154 cm
9" x 60,6"
18,2 x 122 cm
7,2" x 48"



Coordinated steps, skirtings & profiles
Peldaños, rodapiés y perfiles coordinados

Stock available - Stock disponible

Top sales - Top ventas

STONE SERIES
COLECCIÓN PIEDRAS

MARBLE

CRISTAL



MARBLE

CRISTAL



MARBLE



MARBLE CRISTAL

- 30,5 x 61 cm - 12" x 24"
- 46 x 92 cm - 18,1" x 36,2"

Suitable for Apto para		
Total thickness (mm) Espesor total (mm)	6	3,5
Thickness core (mm) Espesor del núcleo (mm)	5	3,5
Wear layer Capa de uso	0,5 mm	0,1 mm
Click type Tipo de click	CLICK V5G	CLICK T&G
Total thickness (mm) Espesor total (mm)	5,5	4,5
Thickness core (mm) Espesor del núcleo (mm)	4,5	4,5
Wear layer Capa de uso	0,5 mm	0,3 mm
Click type Tipo de click	CLICK i4F	CLICK Vilox
Underlayment for acoustic isolation Aislamiento Acústico	dB 17	1mm EVA
Microbevelled edge Micro-bisel		
Standard relief Relieve estándar		
Waterproof Impermeable		
Anti slip - R9 Antideslizante - R9		

46 x 92 cm

30,5 x 61 cm

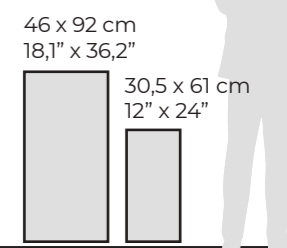

Coordinated steps, skirtings & profiles
Peldaños, rodapiés y perfiles coordinados

Stock available - Stock disponible

Top sales - Top ventas

STONE SERIES
COLECCIÓN PIEDRAS



STONE

GRUNGE

STONE

GRUNGE



STONE

MARQUINA



STONE

ANTRACITA



STONE

GRAFITO



STONE

NÁCAR



STONE



STONE GRAFITO

- 30,5 x 61 cm - 12" x 24"
- 46 x 92 cm - 18,1" x 36,2"



STONE ANTRACITA

- 30,5 x 61 cm - 12" x 24"
- 46 x 92 cm - 18,1" x 36,2"



STONE NÁCAR

- 30,5 x 61 cm - 12" x 24"
- 46 x 92 cm - 18,1" x 36,2"



STONE GRUNGE

- 30,5 x 61 cm - 12" x 24"
- 46 x 92 cm - 18,1" x 36,2"



STONE MARQUINA

- 30,5 x 61 cm - 12" x 24"
- 46 x 92 cm - 18,1" x 36,2"

Suitable for Apto para		
Total thickness (mm) Espesor total (mm)	6	3,5
Thickness core (mm) Espesor del núcleo (mm)	5	3,5
Wear layer Capa de uso	0,5 mm	0,1 mm
Click type Tipo de click	CLICK V5G	CLICK T&G
Total thickness (mm) Espesor total (mm)	5,5	4,5
Thickness core (mm) Espesor del núcleo (mm)	4,5	4,5
Wear layer Capa de uso	0,5 mm	0,3 mm
Click type Tipo de click	CLICK i4F	CLICK V10x
Underlayment for acoustic isolation Aislamiento Acústico	dB 17	1mm EVA
Microbevelled edge Micro-bisel		
Standard relief Relieve estándar		
Waterproof Impermeable		100%
Anti slip - R9 Antideslizante - R9		



Coordinated steps, skirtings & profiles
Peldaños, rodapiés y perfiles coordinados

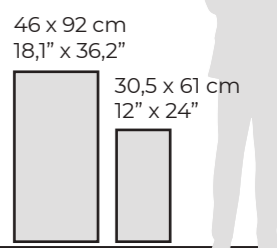

Stock available - Stock disponible

Top sales - Top ventas



THE STEPS ARE MADE TO ORDER

For safety reason, they must be glued to the support to guarantee they stay attached and in place. Support refers to the spot where they are glued to.

LOS PELDAÑOS SE FABRICAN BAJO PEDIDO

Por motivos de seguridad deberán ser pegados al soporte mediante cola para garantizar su fijación.

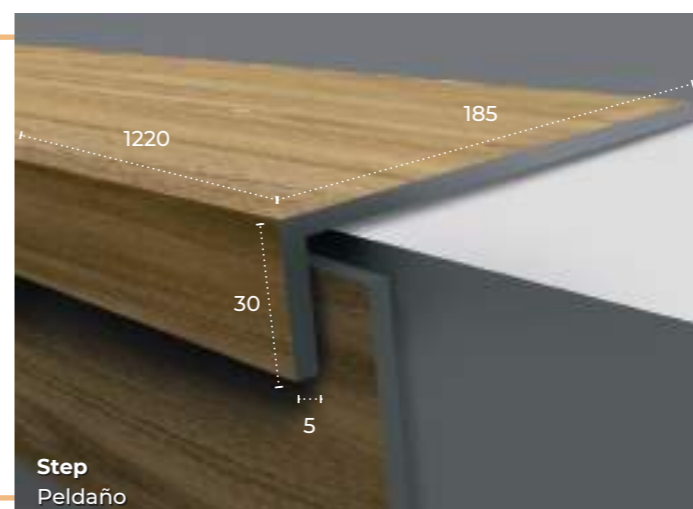

Step
Peldaño

30 x 185 x 1220 x 5 mm

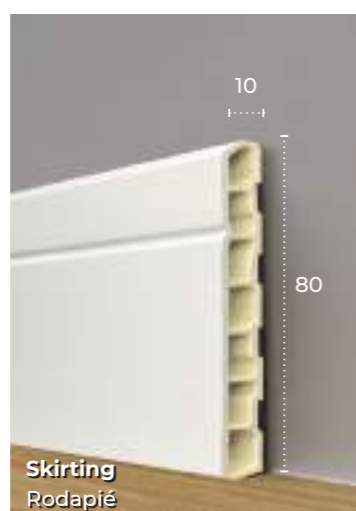
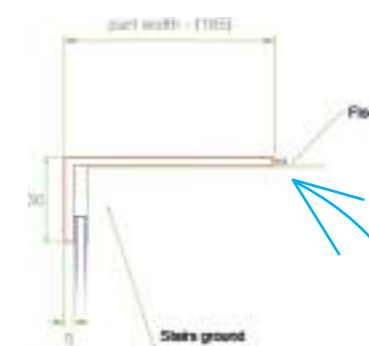

Skirting
Rodapié

White ECO Skirting
80 x 2900 x 10 mm

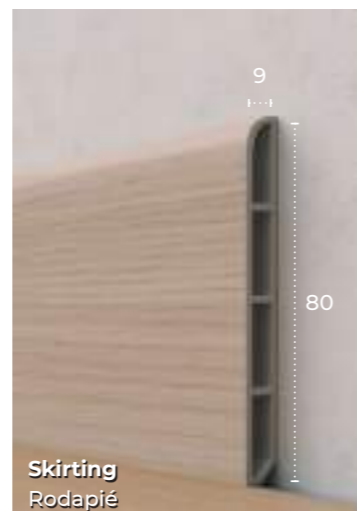

Skirting
Rodapié

Matching Skirting
80 x 2400 x 9 mm

Special parts / Appliances
Piezas especiales / Accesorios

Coordinated steps, skirtings & profiles

Peldaños, rodapiés y perfiles coordinados



Expansion joint recommended every 15 mL
Junta de dilatación recomendada cada 15 mL
Joint d'expansion recommandé pour chaque 15 mL
Empfohlene Dilatationsfuge pro 15 mL



T strip
Perfil de dilatación

Referencia ?????
37 x 900 mm

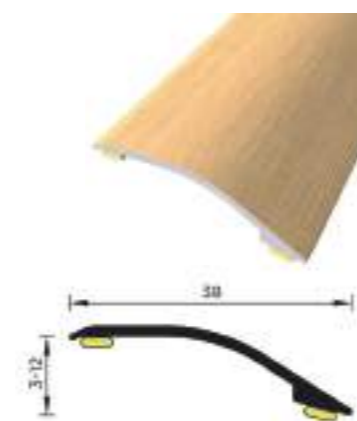

Transition strip
Perfil de transición

Referencia ?????
38 x 900 mm

Finishes that match your pavement

We constantly expand our catalog of profiles and accessories for finishes.

If you do not find what you are looking for here, **contact us**. We will find the perfect solution to finish your project with the excellence you always deserve at a very competitive price.

Acabados que combinan con su pavimento

Ampliamos constantemente nuestro catálogo de perfiles y accesorios para acabados.

Si no encuentra aquí el perfil que necesita **contacte con nosotros**. Encontraremos la solución perfecta para rematar su proyecto con la excelencia que se merece, siempre a un precio muy competitivo.



Wear layer // 20 mil
Capa de uso

Underlayment // 40 mil
Aislamiento acústico

Test and certificates Ensayos y certificados

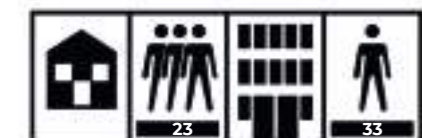

ANALISED CHARACTERISTIC CARACTERÍSTICA ANALIZADA	STANDARD NORMA	UNITS UNIDADES	RESULT RESULTADO
Dimensions Dimensiones	ISO 24337:2006	mm x mm	228 x 1540 182 x 1220 305 x 610 460 x 920
Thickness Espesor	EN ISO 24346	mm	5,5 mm // 6 mm
Thickness tolerance of wear layer Tolerancia de espesor de la capa de desgaste	EN ISO 24340	mm	+13%, -10%
Wear resistance Resistencia de la capa de uso	EN 13329:Annex E	Class Clase	Class 33 / Clase 33 Heavy commercial traffic Tráfico comercial intenso
Formaldehyde Emission Emisión de formaldehído	EN 12149:1997 Test C	mg/m ³	Not detected No detectado
Vinyl Chloride Monomer Monómero de cloruro de vinilo	EN 12149:1997 Test B	mg/kg	Not detected No detectado
Soluble cadmium Cadmio soluble	EN 71-3:1994+AC:2002	mg/m ³	Not detected No detectado
DEHP+BBP+DBP	EN 14372		Not detected No detectado
DNOP+DIDP+DINP	EN 14372		Not detected No detectado
Slip resistance Resistencia al deslizamiento	DIN 51130:2014	Group Grupo	≥ R9
Testing of fire resistance Prueba de resistencia al fuego	EN 13501-1	Class Clase	Class / Clase B1 (B- s1,t0) B1 (B- s1,t0)
Thermal resistance Resistencia térmica	EN 12667	m ² K/W	0.04-0.05 m ² K/W
Static electrical propensity Propensión a la acumulación de cargas electrostáticas	EN 1815	kV	≤ 2,0 kV
Residual indentation Huella residual	ISO 24343-1:2012	mm	≤ 0,1 mm
Peeling strength Resistencia al despegado	ISO 24345	mm	≥ 70 N/50mm
Click tension force Determinación de la fuerza de bloqueo para paneles ensamblados con sistema click	ISO 24334	kN/m	≥ 3 kN/m
Resistance to staining Resistencia a las manchas	EN 26987		No contamination or corrosion Sin contaminación ni corrosión
Curling after exposure to heat Determinación de la estabilidad dimensional y el encorvamiento después de la exposición al calor	ISO 23999	mm	≤ 1 mm
Dimensional Stability Estabilidad dimensional	ISO 24337:2006	%	≤ 0,15 %
Installation gap of click flooring Hueco en la instalación de suelos con clic	ISO 24337:2006	mm	≤ 0,15 mm
Weighted reduction of impact sound pressure level Reducción del nivel de presión acústica de impacto	ISO 717-2:2020	dB	17 dB



Wear layer // 12 mil
Capa de uso



Underlayment // 40 mil
Aislamiento acústico

Test and certificates Ensayos y certificados



ANALISED CHARACTERISTIC CARACTERÍSTICA ANALIZADA	STANDARD NORMA	UNITS UNIDADES	RESULT RESULTADO
Dimensions Dimensiones	ISO 24337:2006	mm x mm	182 x 1220
Thickness Espesor	EN ISO 24346	mm	5 mm
Thickness tolerance of wear layer Tolerancia de espesor de la capa de desgaste	EN ISO 24340	mm	+13%, -10%
Wear resistance Resistencia de la capa de uso	EN 13329:Annex E	Class Clase	Class 32 / Clase 32 General areas with medium traffic Áreas con tráfico general medio
Formaldehyde Emission Emisión de formaldehído	EN 12149:1997 Test C	mg/m ³	Not detected No detectado
Vinyl Chloride Monomer Monómero de cloruro de vinilo	EN 12149:1997 Test B	mg/kg	Not detected No detectado
Soluble cadmium Cadmio soluble	EN 71-3:1994+AC:2002	mg/m ³	Not detected No detectado
DEHP+BBP+DBP	EN 14372		Not detected No detectado
DNOP+DIDP+DINP	EN 14372		Not detected No detectado
Slip resistance Resistencia al deslizamiento	DIN 51130:2014	Group Grupo	≥ R9
Testing of fire resistance Prueba de resistencia al fuego	EN 13501-1	Class Clase	Class / Clase B1 (B-s1,t0) B1 (B-s1,t0)
Thermal resistance Resistencia térmica	EN 12667	m ² K/W	0.04-0.05 m ² K/W
Static electrical propensity Propensión a la acumulación de cargas electrostáticas	EN 1815	kV	≤ 2,0 kV
Residual indentation Huella residual	ISO 24343-1:2012	mm	≤ 0,1 mm
Peeling strength Resistencia al despegado	ISO 24345	mm	≥ 70 N/50mm
Click tension force Determinación de la fuerza de bloqueo para paneles ensamblados con sistema click	ISO 24334	kN/m	≥ 3 kN/m
Resistance to staining Resistencia a las manchas	EN 26987		No contamination or corrosion Sin contaminación ni corrosión
Curling after exposure to heat Determinación de la estabilidad dimensional y el encorvamiento después de la exposición al calor	ISO 23999	mm	≤ 1 mm
Dimensional Stability Estabilidad dimensional	ISO 24337:2006	%	≤ 0,15 %
Installation gap of click flooring Hueco en la instalación de suelos con clic	ISO 24337:2006	mm	≤ 0,15 mm
Weighted reduction of impact sound pressure level Reducción del nivel de presión acústica de impacto	ISO 717-2:2020	dB	17 dB

Technical information
Información técnica

Packing list and displays
Embalajes y expositores

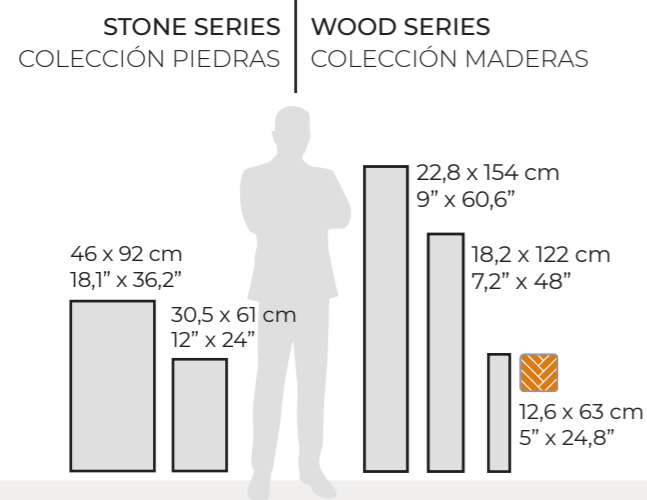

USE USO	SIZE TAMAÑO	SPECIFICATION ESPECIFICACIONES	PALLET SIZE (mm) MEDIDAS PALLET (mm)	PCS / BOX PZS / CAJA	S.Q.M. / BOX m ² / CAJA	Kg / BOX Kg / CAJA	BOX / PALLET CAJAS / PALLET	S.Q.M. / PALLET m ² / PALLET	Kg / PALLET Kg / PALLET	PALLETS / 20'CTN	S.Q.M. / 20'CTN m ² / 20'CTN	Kg / 20'CTN
HERRINGBONE SERIES COLECCIÓN ESPIGA												
	 12,6 x 63 cm - 5" x 24,8"	 	4.5mm/0.5mm SPC+1mm IXPE	126 x 630	24	1,90	18,40	48	91,44	883,20	28	2.560,48 25.569,60
WOOD SERIES COLECCIÓN MADERAS												
 	182 x 1220 - 7,2" x 48"	 	4.0mm/0.3mm SPC+1mm EVA	800 x 1250	10	2,22	18,20	64	142,08	1.195	22	3.126,32 26.285,60
 	228 x 1540 - 9" x 60,6"	 	4.5mm/0.5mm SPC+1mm EVA	1000 x 1570	6	2,11	19,50	60	126,60	1.210	21	2.654,47 25.410,00
STONE SERIES COLECCIÓN PIEDRAS												
 	305 x 610 - 12" x 24"	 	4.5mm/0.3mm SPC+1mm EVA	100 x 125	8	1,49	13,86	66	98,34	945	28	2.750,56 26.453,28
 	460 x 920 - 18,1" x 36,2"	 	5.0mm/0.3mm SPC+1mm EVA	950 x 950	5	2,12	21,94	54	114,48	1.186	20	2.285,80 23.722,80
 	305 x 610 - 12" x 24"	 	4.5mm/0.3mm SPC	1000 x 1250	8	1,49	13,73	78	116,22	1.101	24	2.786,28 26.423,48
 	460 x 920 - 18,1" x 36,2"	 	3.5mm/0.1mm SPC	950 x 950	7	2,96	21,24	60	177,60	1.304	20	3.552,00 26.088,00

Total thickness
Espesor total
Core thickness
Espesor del núcleo
Wear layer
Capa de uso
Underlayment
Aislamiento acústico



Important consumer information
Información importante para el consumidor



Disassemble, move, reassemble... Desmontar, trasladar, volver a montar...

Your home style moves with you

MATERIASPC adapts to the lifestyle of those who, due to circumstances, have a higher geographical mobility.

Furniture, household items, textiles, souvenirs are moved during the removals ... Everything that we like and want to be part of our life.

MATERIASPC floors also move with you to help you create the warmth of your home wherever you are.

El estilo de tu hogar se mueve contigo

MATERIASPC se adapta al estilo de vida de aquellos que, por circunstancias, tienen una movilidad geográfica superior.

En las mudanzas se desplazan muebles, menaje, textiles, recuerdos... Todo aquello que nos gusta y deseamos que forme parte de nuestra vida.

Los suelos MATERIASPC también se mudan contigo para ayudarte a crear allá donde estés la calidez de tu hogar.



See disassembly
instructions in
www.materiaspc.com



Ver instrucciones
de desmontaje en
www.materiaspc.com



No CO₂ emissions in its production Sin emisiones de CO₂ en su producción

Concerned about our legacy

Greater use of resources and less waste generation to increase sustainability and care for the environment. This is our philosophy.

We produce our MATERIASPC coatings exclusively with electrical energy from 100% renewable sources (80% from our own solar panels), generating a zero footprint in CO₂ emissions during manufacture and **we reduce waste generation to a minimum** by reintroducing the remains of the raw materials used back into the manufacturing process. The quality of our products **allows them to be reused**, and no other products (such as adhesives or additional supports) are required during installation, resulting in **an environmentally friendly product**.

Preocupados por nuestro legado

Mayor aprovechamiento de los recursos y menos generación de residuos para incrementar la sostenibilidad y cuidar el medio ambiente. Esta es nuestra filosofía.

Producimos nuestros recubrimientos MATERIASPC exclusivamente con energía eléctrica procedente de fuentes 100% renovables (el 80% procedente de paneles solares propios) generando una huella nula en emisiones de CO₂ durante la fabricación y **reducimos al mínimo la generación de residuos** reincorporando de nuevo al proceso de fabricación los restos de las materias primas empleadas. La calidad de nuestros productos **permite su reutilización**, además de no ser necesarios otros productos (como adhesivos o soportes adicionales) durante su instalación, dando como resultado **un producto respetuoso con el medio ambiente**.



Households
Viviendas



Commercial premises
Locales comerciales



By **EAST COAST SPC, S.A.**

OFFICES & PRODUCT LOADING

OFICINAS y CARGAS

+ 34 / 667 675 984

Carretera CV-20. Km 5.
12200 Onda (Castellón)
SPAIN

www.materiaspc.com